

### Features

- Glass Passivated Die Construction
- Diffused Junction
- Super-Fast Switching for High Efficiency
- High Current Capability and Low Forward Voltage Drop
- Surge Overload Rating to 125A Peak  
Low Reverse Leakage Current
- **Lead Free Finish, RoHS Compliant (Note 4)**

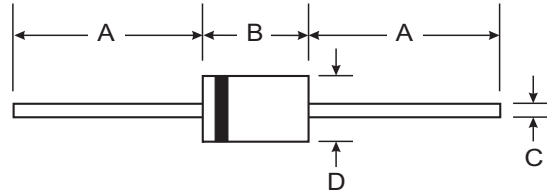

### Mechanical Data

- Case: DO-201AD
- Case Material: Molded Plastic. UL Flammability Classification Rating 94V-0
- Moisture Sensitivity: Level 1 per J-STD-020C
- Terminals: Finish - Bright Tin. Plated Leads Solderable per MIL-STD-202, Method 208
- Polarity: Cathode Band
- Mounting Position: Any
- Ordering Information: See Last Page
- Marking: Type Number
- Weight: 1.12 grams (approximate)

DO-201AD		
Dim	Min	Max
A	25.40	—
B	7.20	9.50
C	1.20	1.30
D	4.80	5.30
All Dimensions in mm		

### Maximum Ratings and Electrical Characteristics @ T<sub>A</sub> = 25°C unless otherwise specified

Single phase, half wave, 60Hz, resistive or inductive load.  
For capacitive load, derate current by 20%.

Characteristic	Symbol	SF30 AG	SF30 BG	SF30 CG	SF30 DG	SF30 FG	SF30 GG	SF30 HG	SF30 JG	Unit	
Peak Repetitive Reverse Voltage Working Peak Reverse Voltage DC Blocking Voltage	V <sub>RRM</sub> V <sub>RWM</sub> V <sub>R</sub>	50	100	150	200	300	400	500	600	V	
RMS Reverse Voltage	V <sub>R(RMS)</sub>	35	70	100	140	210	280	350	420	V	
Average Rectified Output Current (Note 1) @ T <sub>A</sub> = 55°C	I <sub>O</sub>	3.0								A	
Non-Repetitive Peak Forward Surge Current 8.3ms Single half sine-wave Superimposed on Rated Load (JEDEC Method)	I <sub>FSM</sub>	125								A	
Forward Voltage @ I <sub>F</sub> = 3.0A	V <sub>FM</sub>	0.95			1.3		1.5			V	
Peak Reverse Current @ T <sub>A</sub> = 25°C at Rated DC Blocking Voltage @ T <sub>A</sub> = 100°C	I <sub>RM</sub>	5.0				100					μA
Reverse Recovery Time (Note 3)	t <sub>rr</sub>	35			40		50			ns	
Typical Junction Capacitance (Note 2)	C <sub>j</sub>	75						50			pF
Typical Thermal Resistance Junction to Ambient	R <sub>θJA</sub>	32								K/W	
Operating and Storage Temperature Range	T <sub>j</sub> , T <sub>STG</sub>	-65 to +150								°C	

- Notes:
1. Valid provided that leads are maintained at ambient temperature at a distance of 9.5mm from the case.
  2. Measured at 1.0MHz and applied reverse voltage of 4.0V DC.
  3. Measured with I<sub>F</sub> = 0.5A, I<sub>R</sub> = 1.0A, I<sub>rr</sub> = 0.25A. See Figure 5.
  4. RoHS revision 13.2.2003. Glass and High Temperature Solder Exemptions Applied, see *EU Directive Annex Notes 5 and 7*.

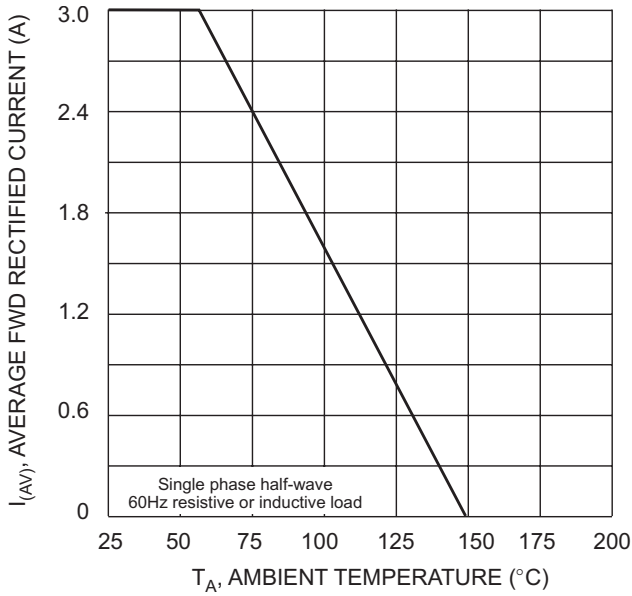

Fig. 1 Forward Current Derating Curve

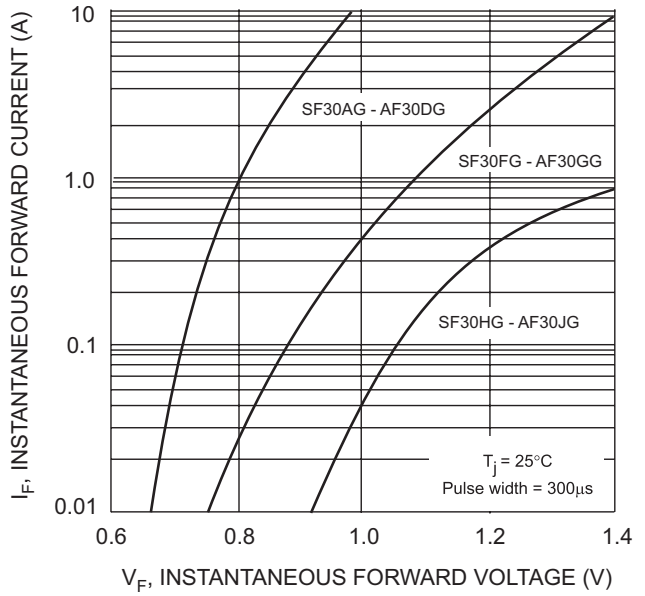

Fig. 2 Typical Forward Characteristics

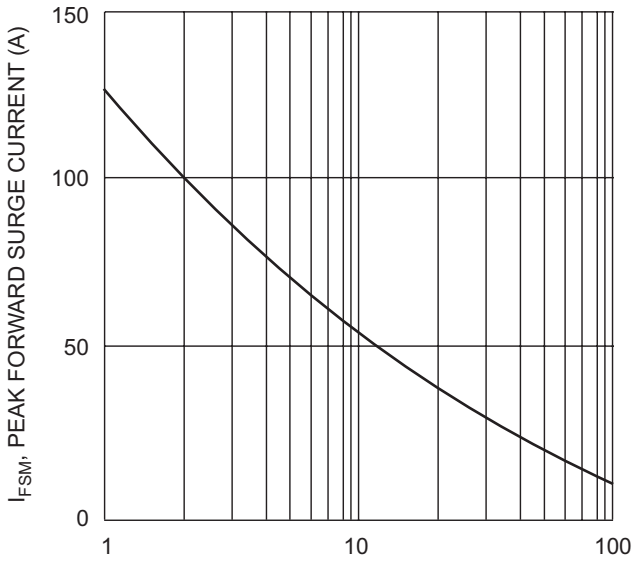

Fig. 3 Peak Forward Surge Current

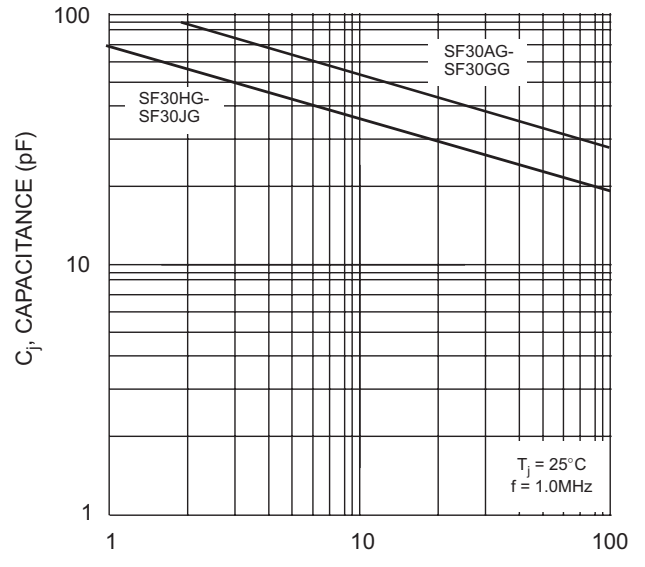
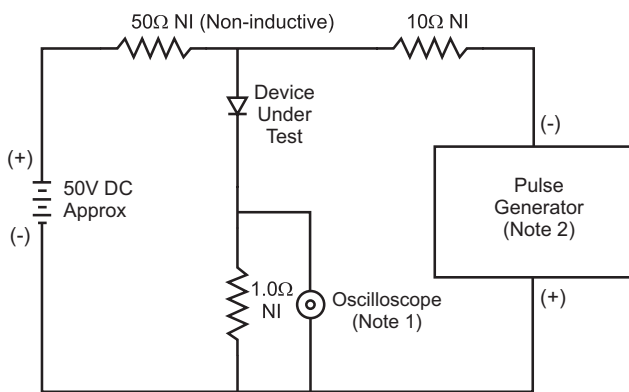
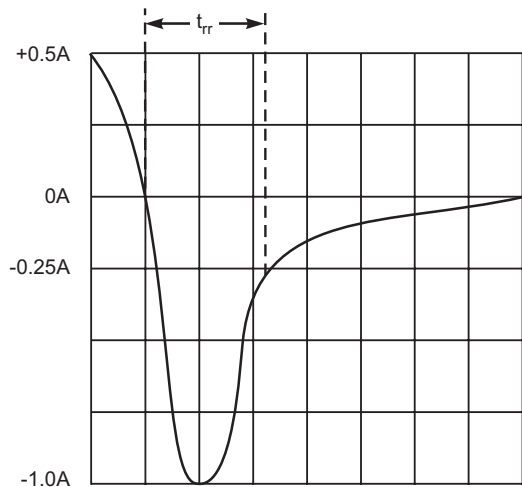

Fig. 4 Typical Junction Capacitance



- Notes:  
 1. Rise Time = 7.0ns max. Input Impedance = 1.0MΩ, 22pF.  
 2. Rise Time = 10ns max. Input Impedance = 50Ω.



Set time base for 50/100 ns/cm

Fig. 5 Reverse Recovery Time Characteristic and Test Circuit

**Ordering Information** (Note 5)

<b>Device</b>	<b>Packaging</b>	<b>Shipping</b>
SF30AG-B	DO-201AD	500/Bulk
SF30AG-T	DO-201AD	1.2K/Tape & Reel, 13-inch
SF30BG-B	DO-201AD	500/Bulk
SF30BG-T	DO-201AD	1.2K/Tape & Reel, 13-inch
SF30CG-B	DO-201AD	500/Bulk
SF30CG-T	DO-201AD	1.2K/Tape & Reel, 13-inch
SF30DG-B	DO-201AD	500/Bulk
SF30DG-T	DO-201AD	1.2K/Tape & Reel, 13-inch
SF30FG-B	DO-201AD	500/Bulk
SF30FG-T	DO-201AD	1.2K/Tape & Reel, 13-inch
SF30GG-B	DO-201AD	500/Bulk
SF30GG-T	DO-201AD	1.2K/Tape & Reel, 13-inch
SF30HG-B	DO-201AD	500/Bulk
SF30HG-T	DO-201AD	1.2K/Tape & Reel, 13-inch
SF30JG-B	DO-201AD	500/Bulk

Notes: 5. For packaging details, visit our website at <http://www.diodes.com/datasheets/ap02008.pdf>.